





CNC SWISS TYPE AUTOMATIC LATHE **Type A** 
SWISS TYPE AUTOMATIC LATHE equipped with star motion control system **Type B** 

SR-20RV

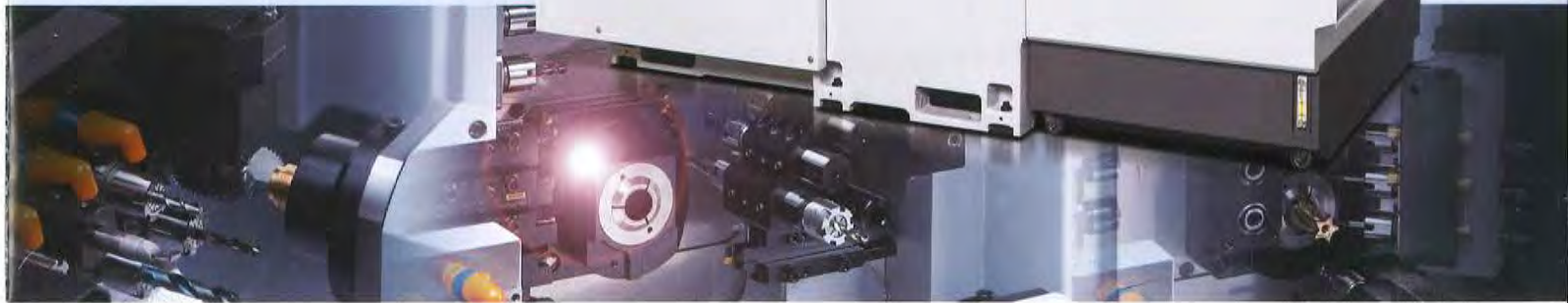

STAR Environmental Standards Conformity models

Impressive Complex Machining to Meet the Needs of Every Field.

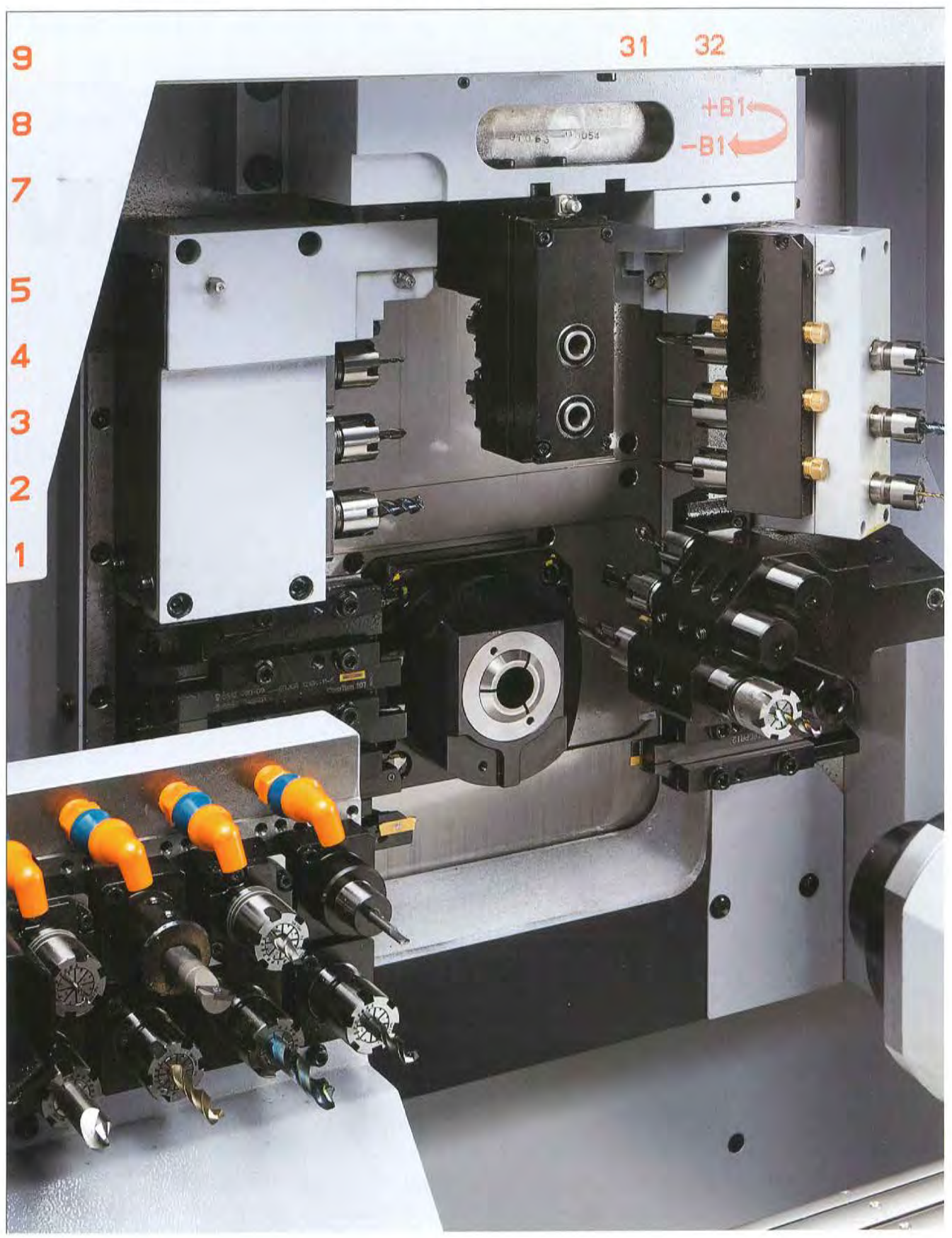

A maximum of 41 tools to mount in the 27-position tool station ensures a flexible tooling layout and allows a variety of complex machining.

The most advanced and powerful model in the SR series with upgraded and enhanced functions.

The theme of development is "the next step for complex machining". Star Micronics aims to be the industry leader by significantly increasing the machining range and decreasing the machining time. This machine has an innovative construction which combines a gantry-type tool post of a uniform load cross guide structure and a tool post especially designed for back-working equipped with a Y-axis control function. A maximum of 41 tools to mount in the 27-position tool station ensures a flexible tooling layout and allows a variety of complex machining

SR-20RV

type A CNC SWISS TYPE AUTOMATIC LATHE

Control method : CNC control

Machine composition :

Main spindle

Sub spindle

Gantry type tool post (Angle adjustable power-driven tool)

Back 8-spindle unit especially designed (Y-axis control)



type B CNC SWISS TYPE AUTOMATIC LATHE equipped with Star motion control system

Control method : CNC control by Star motion control system

Machine composition :

Main spindle

Sub spindle

Gantry-type tool post (B-axis control power-driven tool unit)

8-spindle unit especially designed for back-working (with Y-axis control)

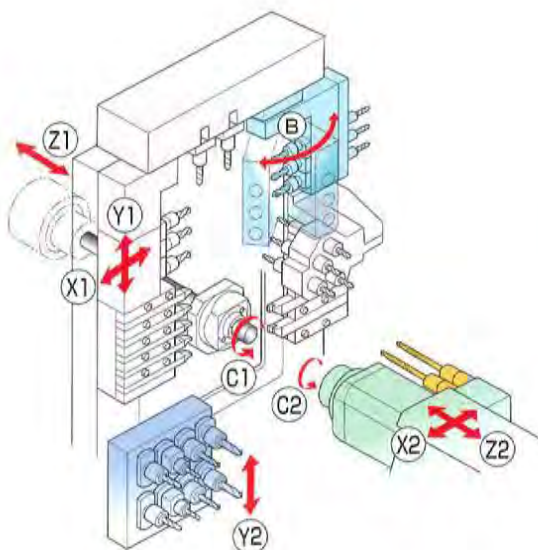

TOOLING SYSTEM

■ Tool holder	Turning tool	7 tools (5 tools on the front / 2 tools on the rear)
■ 4-spindle sleeve holder	Front-end stationary tool	4 tools
	Rear-end stationary tool	4 tools
■ Power-driven tool	Cross machining tool only	3 tools
	Cartridge type	2Pos
	Power-driven tool unit *	1 Pos (front 3 tools / rear 3 tools)
■ 2-spindle front sleeve holder	Front-end stationary tool	2 tools
■ Back 8-spindle unit	Rear-end stationary tool	Max. 8 tools
	Rear-end power-driven tool	Max. 8 tools

* type A : Angle adjustable power-driven tool / type B : B-axis control power-driven tool unit

Upgraded Design Features such as Machining Accuracy, Productivity and Environmental Friendliness.

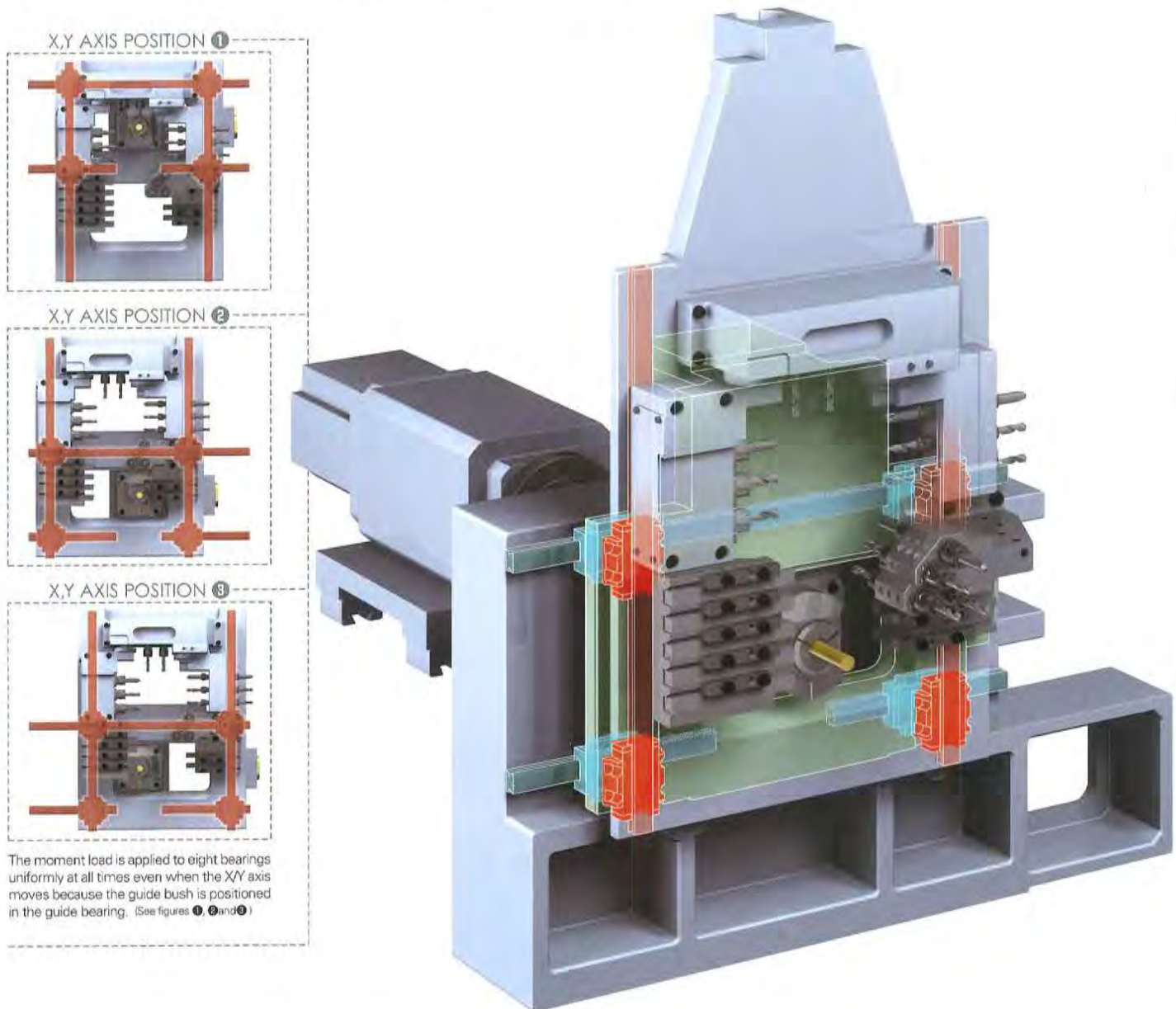

03

The moment load is applied to eight bearings uniformly at all times even when the XY axis moves because the guide bush is positioned in the guide bearing. (See figures 1, 2 and 3)

Original Technology

Uniform Load Cross Guide Structure

High rigidity tool post

High Accuracy from High Rigidity Design

① Newly Incorporated Uniform Load Cross Guide Structure

A newly employed tool post, which has eight direct-acting guide bearings uniformly arranged around a point (guide bush) to which a cutting load is applied, is featured. By distributing the load applied during cutting uniformly to eight guide bearings, the moment load

applied to each guide bearing is minimized and the rigidity of the tool post is increased. Dynamic stability is also improved to allow long-term continuous operation with stable accuracy and long service life of direct-acting guide bearings.

② Built-in Motor and Sensor

Indexing accuracy is improved by integrating a motor drive and a sensor in the spindle and sub spindle.

Improved Machining Capability by Increased Output Power

①Rear-end working capability is increased by employing a built-in spindle motor with the same output power as that of the sub spindle and the main spindle.

②Thanks to the increased power of motors for power-driven tools for cross machining and back-end working, the range of machining is widened for broader range of needs.



Main spindle (built-in type)



Sub spindle (built-in type)

Non-Guide Bush to Reduce Remnant Bar Length

With the non-guide bush type, the material is clamped close to the machining position so that the remnant bar length is reduced to about 1/3 compared to the Swiss-type lathe. By switching to the non-guide bush type where appropriate, the material cost is reduced.

*Elimination of the guide bush makes machining of short bars easier and enables material to be used more effectively.

By proceeding with the job in accordance with the procedures displayed on the operation panel, switching from the guide bush type to non-guide bush type is easily accomplished.



Pursuing High Productivity

- ①The latest CNC unit reduces program processing time significantly.
- ②The higher model Type B is equipped with the Star original motion control system to minimize non-cutting time such as control system switching time and tool changing time.
- ③High-speed feed at 35m/min (for other than the Y2 axis) is achieved.

④Acceleration is also improved (1 = 1.2G).

⑤A direct C-axis indexing function is provided to reduce the spindle indexing time. The above features are all for productivity enhancement from the aspect of both the mechanical and control systems.

Original Technology

Significant Reduction of Non-Cutting Time

Star Motion Control System

This control system converts the NC program through "optimization" and finishes processing related to switching of the control system in order to enable "tool selection for the next process and approach during cutting" and "tool disengagement and next cutting at the same time".

By this control method, the non-cutting time, which is considered to be a disadvantage for NC-controlled machines, is largely reduced and contributes to improved productivity. - Furthermore, this control system moves each axis while taking the shortest way, utilizing the previous cutting process time to minimize excessive vibration caused by axis feed and contributes to the maintenance of stable machining accuracy.

By the program optimization, the time required for the processes of [Disengagement], [Next tool selection] and [Approach] can be minimized to reduce the non-cutting time.

① Concept of reduction of non-cutting time

Conventional CNC-controlled machining



② Concept of cutting time reduction

Conventional CNC-controlled machining

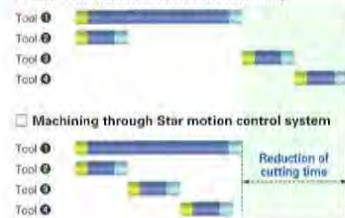

Pursuit of Environmental Performance

The remnant bar length has been reduced by 15.5mm from that of Version III, hydraulic-less structure for reducing waste oil and power consumption, adoption of powder coating, RoHS-compliant design, etc. are combined to contribute to the effective environmental performance in response to the people- and earth-friendly age.



STAR Environmental Standards Conformity models

Star Micronics defines machine tools conforming to the following environmental standards as "Star Environmentally Compatible Machines".

Adaptation Criterion

- Powder-coated external cover
- RoHS compliance part ratio: 99% or more

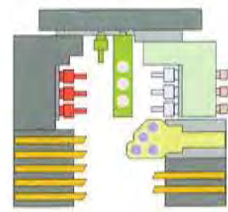
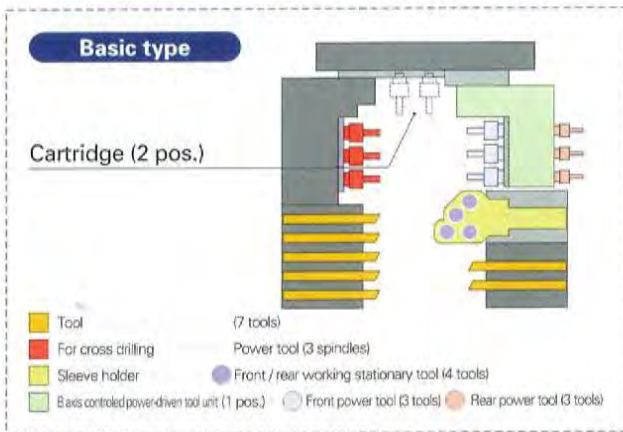

VARIATION 02

Cartridge (2 pos.)



■ Milling unit
■ 3-spindle front drill unit
■ Milling unit
■ 3-spindle opposing type front drill unit

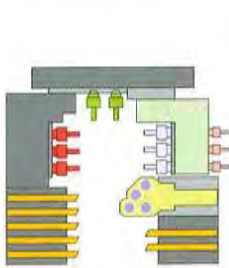

VARIATION 01

Cartridge (2 pos.)



■ Milling unit
■ Milling unit

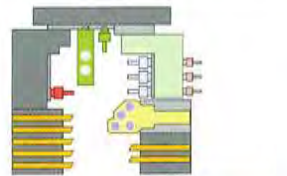

VARIATION 03

Cartridge (2 pos.)



■ 2-spindle front drill unit
■ Milling unit
■ Milling unit
■ 2-spindle front drill unit

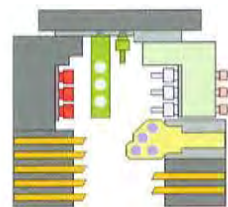

VARIATION 04

Cartridge (2 pos.)

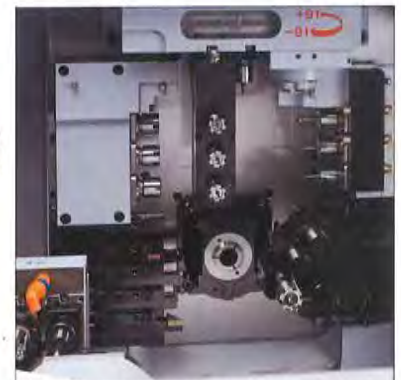

■ 3-spindle front drill unit
■ Milling unit
■ 3-spindle opposing type front drill unit
■ Milling unit

A maximum of 41 tools can be mounted in the 27-position tool station. A full line of tool units includes milling tools, thread whirling tools, slotting tools, polygon turning tools. Therefore, the most suitable tooling layout can be selected from a wide range of tooling layouts, from a basic type through a front-end power-driven tool oriented type. A 2-spindle drill sleeve holder for deep-hole drilling is also mounted to cover a maximum of 100mm-diameter machining to expand the number of possible machining variations.

Tool unit (main side)



33150 Milling unit



67161 3-spindle opposing front drill unit



54151 2-spindle face drill unit



68172 Thread whirling unit



OT191 Polygon machining unit



Tooling Layouts.

TOOLING SYSTEM

8-spindle backworking unit

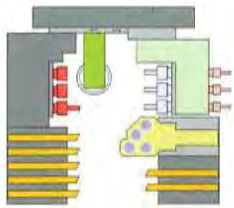

VARIATION 05

Cartridge (1 pos.)

Special machining unit mounted (polygon)

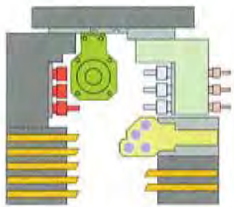

VARIATION 06

Cartridge (1 pos.)

Special machining unit mounted (thread whirling)

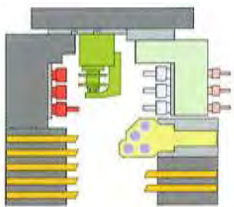

VARIATION 07

Cartridge (1 pos.)

Special machining unit mounted (slotting)

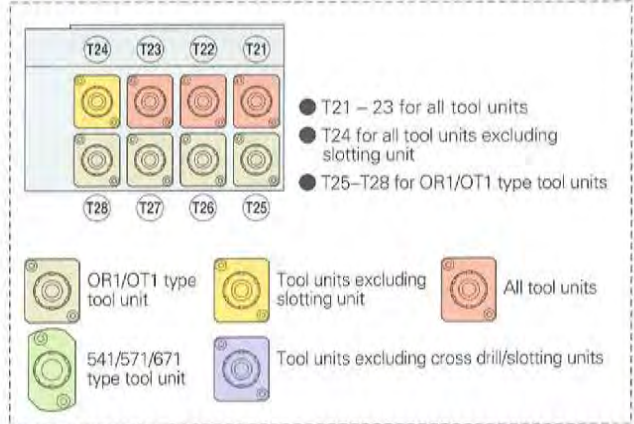

541/571/671 type unit mounting conditions

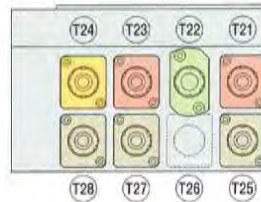

● When the 541/571/671 type unit is mounted, other tool units cannot be mounted on the lower position.

Cross drill unit/slotting unit mounting conditions

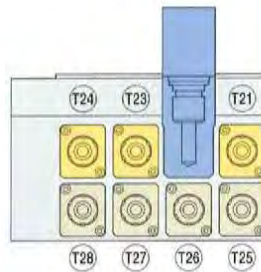

● When the cross drill unit is mounted
The slotting unit cannot be mounted on the neighboring positions.

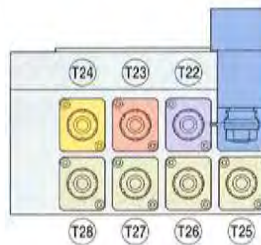

● When the slotting unit is mounted
The cross drill unit/slotting unit cannot be mounted on the neighboring positions.

06

Tool unit (back side)



54153 Slotting unit



QR161 Milling unit



OR151 Cross drill unit



OR165 Slotting unit

A Broad Range of Machining Variations, Using the 27-Position

■ The 27-position tool station can accommodate a maximum of 41 tools to allow a variety of tooling layouts. ■ A B-axis control power-driven tool unit or angle adjustable power-driven tool unit are available. ■ Various tool units mainly for polygon turning and the

VARIATION 01 Front-end working

B axis swing of power driven-tool with B axis
*type B only

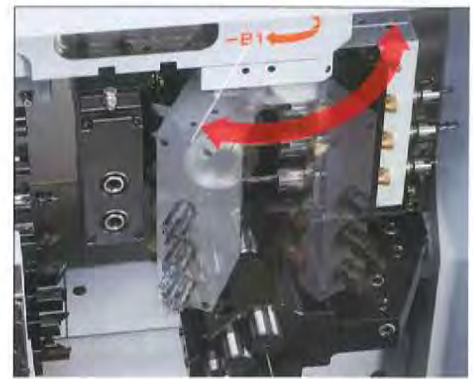
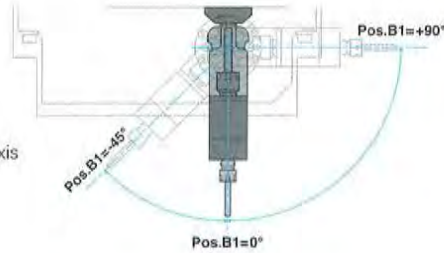

VARIATION 02 Front-end working

Diagonal machining by power-driven tool
with B axis/angle adjustable power-driven tool

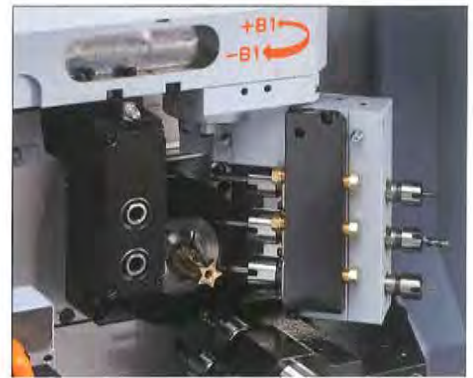
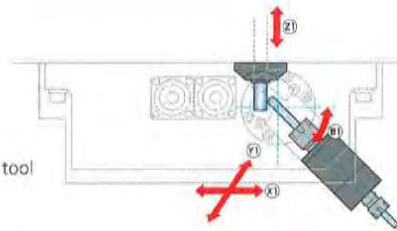

VARIATION 03 Front-end working

Front off-center drilling

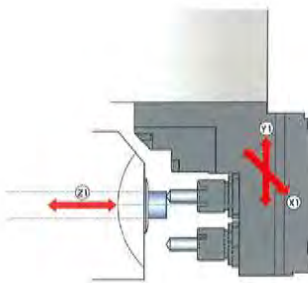

VARIATION 04 Front-end working

Cross drilling

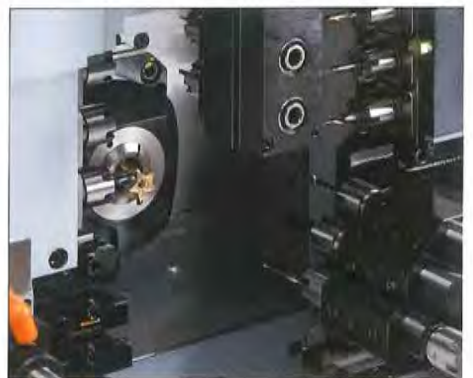
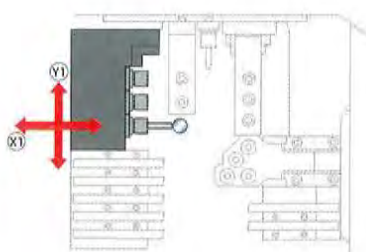

on Tool Station.

Lead whirling are also available. ■ A 2-spindle sleeve holder for deep-hole drilling is mounted to allow a maximum of 100mm-deep hole machining. ■ 8-spindle backworking unit with Y axis allows many different types of complex machining on the rear side.

VARIATION 05
Rear-end working
Back cross drilling

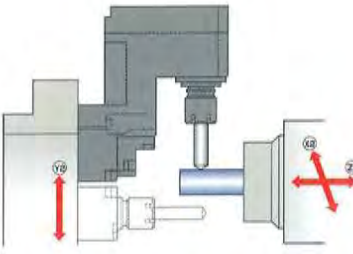



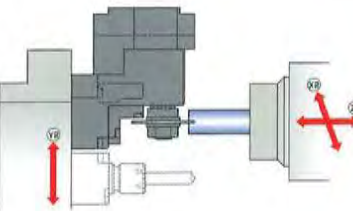

VARIATION 06
Rear-end working
Back slotting

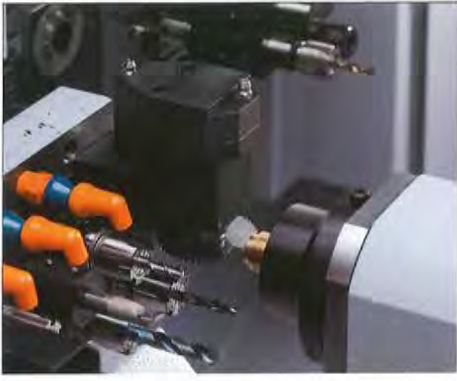

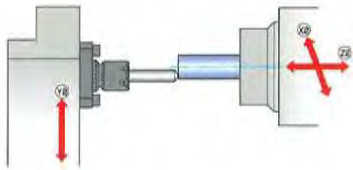

VARIATION 07
Rear-end working
Back off-center drilling





VARIATION 08
Rear-end working
Back diagonal machining using power-driven tool with B axis/angle adjustable power-driven tool

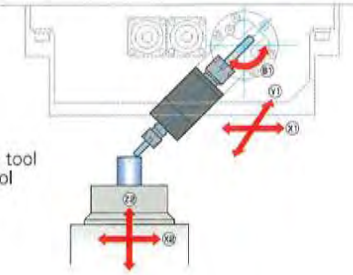

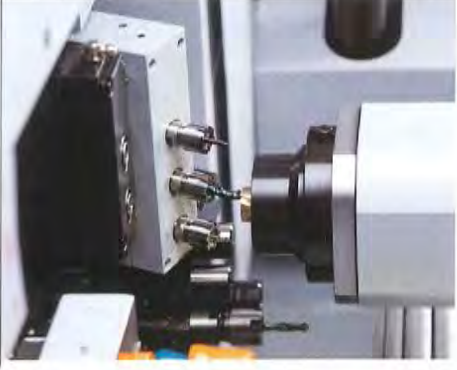

The NC System Continues to Evolve to be Friendly to Every Operator.

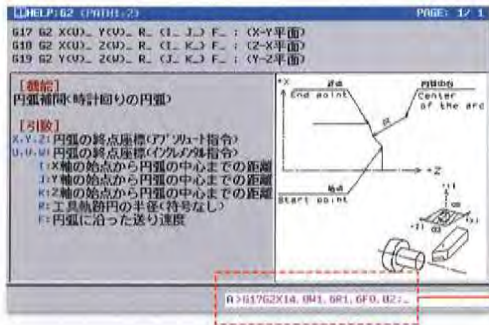

Advanced Command Help Screen

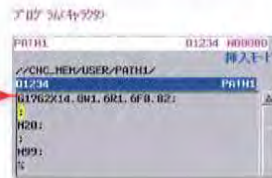

Graphics display on the command help screen eases the monitor of check command details on the screen. This enables understand the help contents more instinctively than the conventional method. By inputting codes while displaying the help contents, insertion into the currently edited program is also possible.

Convenient Alarm Help Function

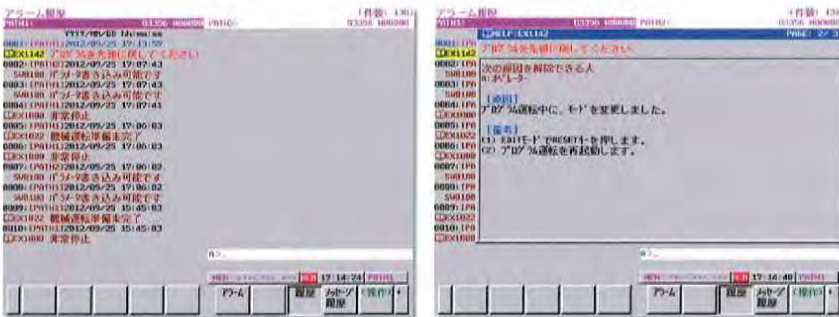

The Star original alarm help screen is added. When [Help] is selected from the bookmark, the pop-up screen is displayed and alarm details can be checked even if there is no instruction manual. Together with the troubleshooting information, a list of personnel who can remove the alarm is also displayed to clear the problem smoothly.

Multi-System Program Control

Program input/output between the NC unit and the memory card can be done by a single operation for all systems. Programs for all systems can be compiled in one file (with extension ".AP"). Copy, delete and new creation can also be done by one operation.

*Files with an extension ".PA" are supported by Star program control software "PU-Jr." Non-compliant models will gradually changed to be compliant in the future.

多系統プログラム管理		
PATH1:	01000 000000	PATH2:
多系統プログラム	使用バグ 空きバグ	メモリーカード
ファイル名	CNC_MER	00001.PA
00006		00002.P1
01000		00050.PA
01006		00150.P2
01007		01003.PA
01111		01234.PA
01212		01650.PA
02222		02000.P1
02333		02250.PA
03090		03357.PA
03093		03358.PA
03111		03359.P2
		05075.P1
		TEST.PA



A count arrival forecast function is newly added to the tool life management.

カウント到達予報 ON
カウント到達予報時間 14:03

工具	アリット	カウント	工具	アリット	カウント
10100	10000	1000	13100	35000	1000
10200	20000	1000			
10300	10000	1000			
10400	15000	1000	13200	25000	1000
10500	10000	1000			
10700	20000	1000			
10800	20000	1000			
10900	30000	1000			

Tool life can be managed for each tool number. The count arrival forecast function also gives warning through the count arrival forecast time display, tool counter red display and operator message (No. 2047) display if any tool life is expected to expire within 24 hours. With this function, the operator can prepare a replacement tool before the machine stops and reduce the non-running time.

Convenient Tool Selection Function

ツール選択

PATH1

ツール	X	Y	Z	H	W	コメント
101	0.000	0.000	0.000	0.000	0	(10100)
102	0.000	0.000	0.000	0.000	0	(10200)
103	0.000	0.000	0.000	0.000	0	(10300)
104	0.000	0.000	0.000	0.000	0	
105	0.000	0.000	0.000	0.000	0	
106	0.000	0.000	0.000	0.000	0	
107	0.000	0.000	0.000	0.000	0	
108	0.000	0.000	0.000	0.000	0	
109	0.000	0.000	0.000	0.000	0	
110	0.000	0.000	0.000	0.000	0	
111	0.000	0.000	0.000	0.000	0	
112	0.000	0.000	0.000	0.000	0	
113	0.000	0.000	0.000	0.000	0	
114	0.000	0.000	0.000	0.000	0	
115	0.000	0.000	0.000	0.000	0	
116	0.000	0.000	0.000	0.000	0	

A tool selected on the screen can be positioned while the door of the machining chamber is opened. Two buttons need to be pressed at the same time to take safety into consideration during the work.

ツール選択

アプローチ位置

ツール	X	Y	Z	H	W	コメント
101	0.000	100	120	120	120	
111	0.000	150	110	120	120	
121	0.000	100	110	120	120	
131	0.000	100	110	120	120	
141	0.000	100	110	120	120	
151	0.000	100	110	120	120	
161	0.000	100	110	120	120	
171	0.000	100	110	120	120	
181	0.000	100	110	120	120	
191	0.000	100	110	120	120	

Convenient Wear Offset Screen

The tool wear offset number which is used is displayed on the right end of the screen during execution of the machining program. This enables to check the applicable offset number easily when changing the offset value.

Convenient Undo Function

In case of the wrong input, simply press the [Undo] key to revert back to the previous value.

*The undo function is usable on the wear offset screen and geometry offset screen.

Simple Spindle Phase Synchronization Function

The spindle phase synchronization for machining profile bars required complicated procedures with conventional models, but this procedure is partially automated by this function. Simple button operation following the instructions displayed on the screen enables smooth adjustment.

Insulation Deterioration Detecting Function Added

Insulation deterioration associated with the servo motor, spindle motor and their power lines is automatically detected. Therefore, potentially hazardous sections can be located before the machine is stopped to enable maintenance and replacement of parts ahead of time.

□ Standard Machine Specifications

Item	Specifications	
Max. machining diameter	φ20mm(25/32in)	
Max. headstock stroke	Standard	205mm(8in)
	With R.M.G.B. unit	180mm(6-19/64in)
	Non-guide bush type	Bar diameter×2.5(Max.50mm) (Max.1-31/32in)
Tool	5 tools on the front + 2 tools on the rear (□12mm)	
4-Spindle sleeve holder	Number of tools	Front 4 tools Rear 4 tools
	Max. drilling capability	φ12mm(1/2in)
	Max. tapping capability	M10×P1.5
2-spindle front sleeve holder	Number of tools(sleeve)	2 tools
	Max. drilling capability	φ10mm(25/64in)
	Max. depth of hole	100mm (3-15/16in)
Power driven attachment	Number of tools	Cross milling : 3 tools Cartridge type : At 2 position
	Number of tools (type A)	Angle adjustable power-driven tool : At 1 position (Front 3 tools+Rear 3 tools)
	Number of tools (type B)	B-axis controlled power-driven tool unit : At 1 position (Front 3 tools+Rear 3 tools)
	Max. drilling capability	φ10mm(25/64in)
	Max. tapping capability	M8×P1.25
	Spindle speed	Max.8,000min ⁻¹
	Drive motor	2.2kw
Rapid feed rate	35m/min(X1,X2,Y1,Z1,Z2), 15m/min(Y2)	
Main spindle indexing angle	C-axis control	
Main spindle speed	Max.10,000min ⁻¹	
Main spindle motor	2.2kw(continuous)/3.7kw(10min./25%ED)	
Coolant tank capability	170ℓ	
Dimensions (W×D×H)	2,334×1,200×1,700mm	
Weight	2,600kg	
Power consumption	4.7KVA	
A-weighted sound pressure : note-1	Max. 74.5dB	

□ Backworking Attachment Specifications

Item	Specifications	
Max. chucking diameter	φ20mm(25/32in)	
Max. length for front ejection	80mm(3-5/32in)	
Max. parts projection length	30mm(1-3/16in)	
Back 8-Spindle unit	Number of tools	Stationary tool : 8 tools Power driven tool : 8 tools
	Max. drilling capability	Stationary tool : φ12mm(1/2in) Power driven tool : φ6mm(15/64in)
	Max. tapping capability	Stationary tool : M10×P1.5 Power driven tool : M5×P0.8
	Power-driven att. spindle speed	Max.8,000min ⁻¹
Power-driven att. drive motor	1.0kw(continuous)/1.2kw(5min./30%ED)	
Sub spindle indexing angle	C-axis control	
Sub spindle speed	Max.10,000min ⁻¹	
Sub spindle motor	Built-in motor drive 2.2kw(continuous)/3.7kw(10min./25%ED)	

□ External Dimensions

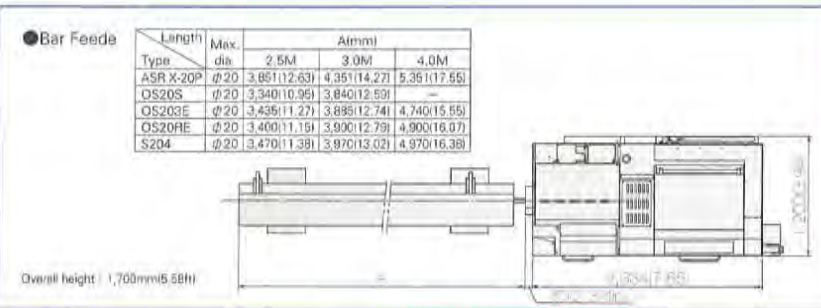

※Design features, specifications and technical execution are subject to change without prior notice.

※This product is an export control item subject to the foreign exchange and foreign trade laws. Thus, before exporting this product, or taking it overseas, contact your STAR MICRONICS dealer.

STAR MICRONICS CO., LTD.

Machine Tools Division

1500-34 Kitanoya, Misawa, Kikugawa, Shizuoka, 439-0023 Japan

America, Europe Sales TEL:+81-537-36-5594 FAX:+81-537-36-5607
Asia Sales TEL:+81-537-36-5574 FAX:+81-537-36-5607

Star CNC Machine Tool Corporation
123 Powerhouse Road, Roslyn Heights NY11577,U.S.A.
TEL:+1-516-484-0502 FAX:+1-516-484-5820

Star Micronics GB Limited
Chapel Street, Melbourne, Derbyshire DE73 3JF,U.K.
TEL:+44-1332-86-44-25 FAX:+44-1332-86-40-05

Star Micronics GmbH
Robert-Grob-Str. 1, D-75305 Neuenbürg, Germany
TEL:+49-7082-7920-0 FAX:+49-7082-7920-20

Star Micronics AG
Lautstrasse3, CH-8112 Otelfingen, Switzerland
TEL:+41-43-411-60-80FAX:+41-43-411-60-85

Star Machine Tool France
90 Allée de Galatay, ZI, 74300 Thyez Haute Savoie, France
TEL:+33-450-96-05-97FAX:+33-450-96-91-54

Shanghai Xingang Machinery Co., Ltd.
229 Fute Road(N) Waigaoqiao F. T. 2, Shanghai200131, P.R.China
TEL:+86-21-5868-2100FAX:+86-21-5868-2101

Star Micronics (Thailand) Co., Ltd.
259/23 M.13 Soi Kingkaew 25/1, Kingkaew Rd., T.Rachatewms A, Bangplee Samutprakom 10540, Thailand
TEL:+66-2-186-8945-47FAX:+66-2-183-7845

□ Standard Accessories and Functions

- CNC unit FANUC 31i-B (typeA)
CNC unit FANUC 31i-B5 (typeB)
- Operation panel 10.4-inch color LCD display
- Pneumatic unit
- Automatic centralized lubrication unit
- Coolant level detector
- Door interlock system
- Broken cutoff tool detector
- Parts ejection detector
- Drive unit for revolving guide bush
- Revolving guide bush unit
- Main/Sub collet
- C-axis control (Main/Sub)
- Spindle clamp unit (Main/Sub)
- 5-station tool holder □12mm
- 2-station tool holder □12mm
- Main tool post tool rotation drive unit
- Cross milling tool unit (3-tool type)
- Angle adjustable power-driven tool unit (Type A)
- B-axis controlled power-driven tool unit (Type B)
- 4-spindle sleeve holder
- Back 8-spindle unit
- Drive unit for power-driven attachment B
- Y-axis control for back-working tool post
- Parts ejector (Spring type)
- Parts conveyor
- Air purge for revolving guide bush
- Sub spindle air purge unit
- Sub spindle air blow unit
- Work light
- Leakage breake

□ Optional Accessories and Functions

- Coolant flow detector
- Water removal unit
- Beacon
- Parts receptacle in the machine
- Parts separator unit A
- Main spindle inner tube
- Parts ejector (Air cylinder type)
- Rotary magic guide bush unit
- Parts ejector with guide tube
- Parts stopper unit
- Coolant unit 2.5MPa
- Coolant unit 6.9MPa
- Coolant pipings
- Oil-hole drill type
- Automatic bar feeder interface
- Compliant with the RS-232C interface
- Transformer
- Safety relay module version
- Transformer CE marking version
- Transformer CE marking specifications

Note)

The machining capacities apply to SUS303 material. The machining capacities may differ from listed values depending on the machining conditions, such as the material to be machined or the tools to be used.

note-1 ● Measures conforming to ISO standard

● A-weighted sound pressure is a general assessment standard characteristic that connected the sound level to human acoustic sense.

<http://www.star-m.jp/eng/>

9001 ISO 14001
CERTIFIED